

SINGLE-STAGE AND MULTI-FUNCTION VACUUM GENERATORS SERIES AVG

These generators are independent vacuum units that can control an entire vacuum gripping system. They have been specially designed for the AUTOMOTIVE sector and they are equipped with single ejectors that, given the same capacity as the multi-ejector generators, allow a quicker grip and, as a result, a greater compressed air consumption. As a standard, they are provided with a built-in pneumatic energy-saving device. They are composed of an anodised aluminium monobloc structure, inside of which are installed the ejectors, the servo-controlled slide valve for the compressed air supply and are contained the vacuum chambers as well as the various connections.

On the outside, on the other hand, are installed:

- *A bistable impulse solenoid valve for controlling the slide valve.*
- *A micro solenoid valve for blowing the exhaust compressed air.*
- *A flow regulator for dosing the exhaust compressed air.*
- *Two silencers for removing noise from the ejected air.*
- *An aluminium manifold provided with vacuum connections with built-in:*
 - ° *A pneumatic vacuum switch for managing the compressed air supply according to the set vacuum level (energy saving).*
 - ° *A check valve for maintaining the vacuum in case of electricity or compressed air failure.*
 - ° *A suction filtre, easy to inspect through the transparent polycarbonate lid.*

By providing an electric impulse to the two-position micro solenoid valve, the compressed air supply slide valve will be activated and vacuum will be created at the application.

Once the preset maximum value has been reached, the pneumatic vacuum switch, acts on the slide valve and interrupts the compressed air supply, restoring it when the value returns below the minimum value.

Along with maintaining the vacuum level within the preset safety values, this modulation allows saving a considerable amount of compressed air, even in case of electricity failure. Once the work cycle is completed, an electric impulse deactivates the supply micro solenoid valve and, at the same time, the ejection micro solenoid valve for a quick restoration of the atmospheric pressure at the application.

AVG vacuum generators are set for the installation of a micro digital vacuum switch art. 12 05 11 at the application and, upon request, they can be supplied protection devices against shocks and accidental falls.

Also these vacuum generators can be installed in any position.

AVG vacuum generators are suited for controlling vacuum cup gripping systems, for handling sheet metal, glass, marble, ceramic, plastic, cardboard, wood, etc., and, in particular for the AUTOMOTIVE sector, which requires equipment with excellent performance and reduced overall dimensions and weight.

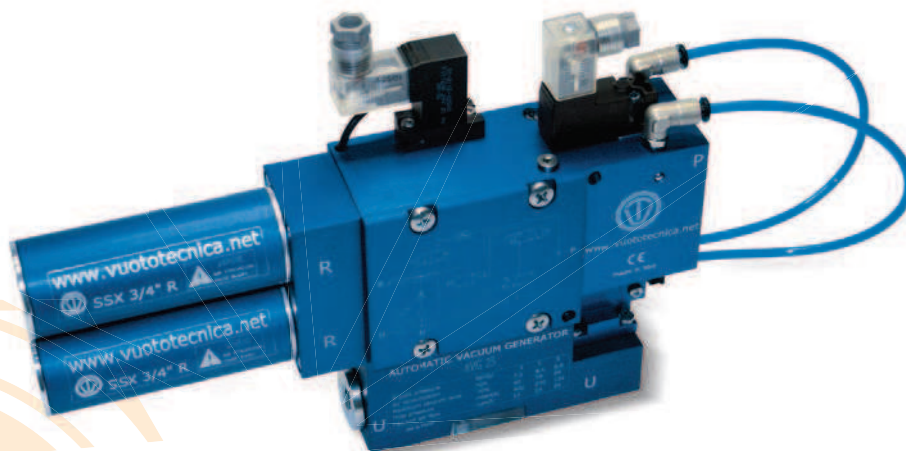

SINGLE-STAGE AND MULTI-FUNCTION VACUUM GENERATORS AVG 18 and AVG 25

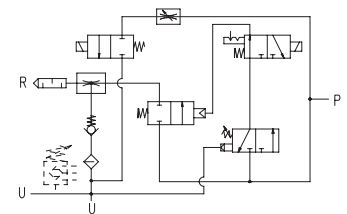
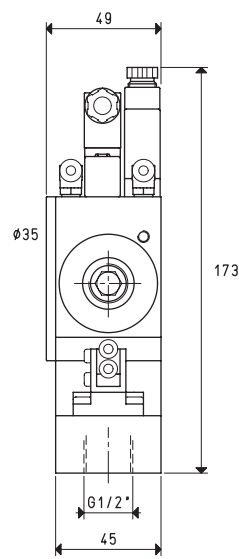
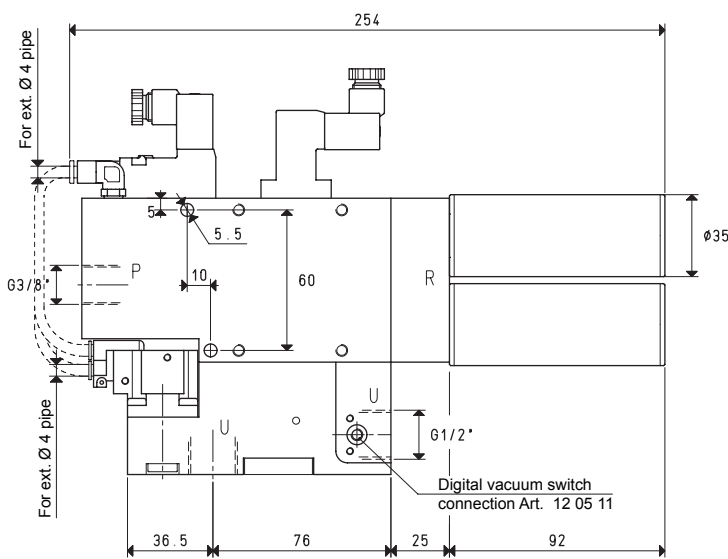
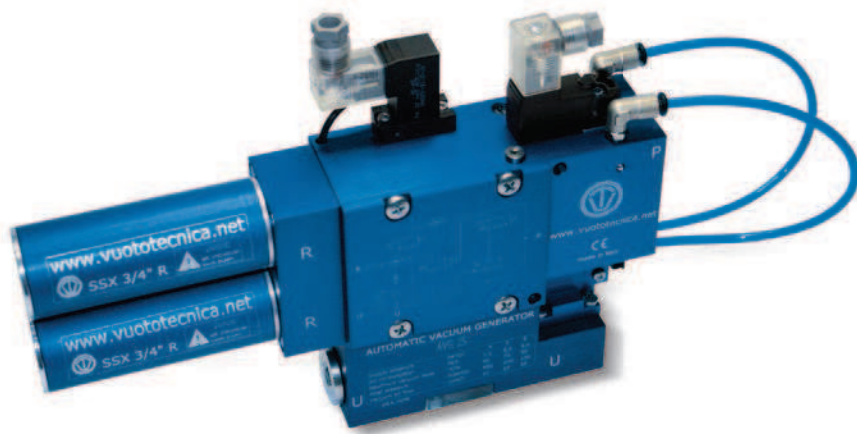

P=COMPRESSED AIR CONNECTION R=EXHAUST U=VACUUM CONNECTION

Art.		AVG 18					AVG 25
Max. quantity of sucked air	cum/h	16.5	17.0	17.4	24.5	25.0	25.2
Max. vacuum level	-KPa	60	70	85	60	70	85
Final pressure	mbar abs.	400	300	150	400	300	150
Supply pressure	bar (g)	4	5	6	4	5	6
Air consumption	l/s	4.3	5.3	6.4	6.5	8.0	9.6
Max. quantity of air blown at 6 bar (g)	l/min			140			140
Bistable supply solenoid valve	NO/NC			NO/NC			NO/NC
Electric absorption	W			1			1
Ejection solenoid valve position	NC			NC			NC
Electric absorption	W			4			4
Supply voltage	V			24 DC			24 DC
Class of protection	IP			65			65
Working temperature	°C			-10 / +60			-10 / +60
Noise level	dB(A)			63			65
Weight	Kg			1.67			1.67

Note: To order the generator provided with digital vacuum switch, add the letter V to the code (e.g.: AVG 25 V).

Note: All the vacuum data indicated in the table are valid at the normal atmospheric pressure of 1013 mbar and are obtained with a constant supply pressure.

Conversion ratio: inch = $\frac{mm}{25.4}$; pounds = $\frac{g}{453.6}$ = $\frac{Kg}{0.4536}$

GAS-NPT thread adapters available at page 1.117

SINGLE-STAGE AND MULTI-FUNCTION VACUUM GENERATORS AVG 18 and AVG 25

Air capacity (NI/s) at different vacuum levels (-Kpa)

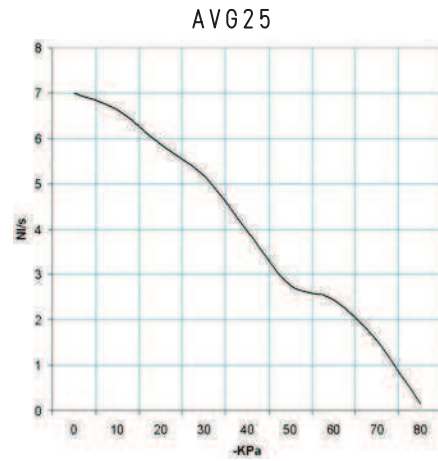
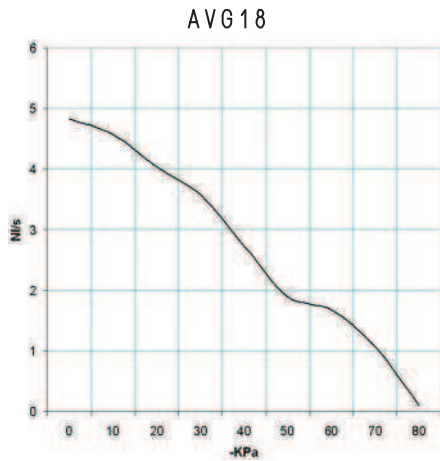

Generator art.	Supply press. bar (g)	Air consumption NI/s	Air capacity (NI/s) at different vacuum levels (-KPa)										Max. vacuum level -KPa
			0	10	20	30	40	50	60	70	80		
AVG 18	6.0	6.4	4.83	4.58	4.04	3.58	2.72	1.90	1.68	1.07	0.10	85	
AVG 25	6.0	9.6	7.00	6.63	5.86	5.18	3.94	2.76	2.44	1.54	0.15	85	

Evacuation time (ms/l = s/m³) at different vacuum levels (-Kpa)

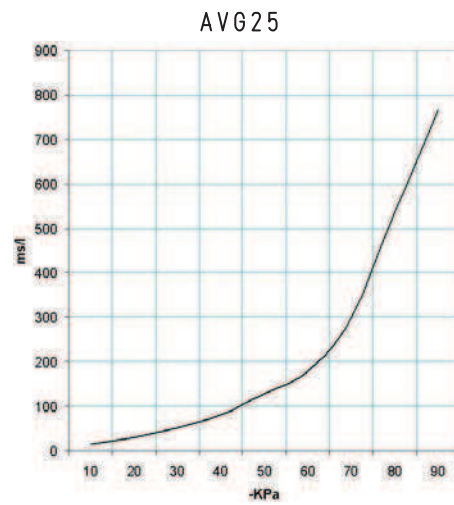
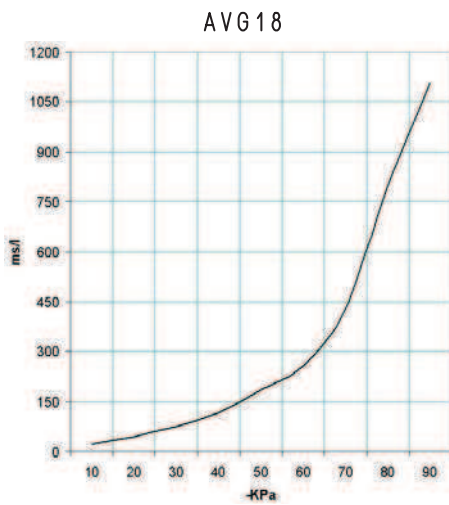

Generator art.	Supply press. bar (g)	Air consumption NI/s	Evacuation time (ms/l = s/m ³) at different vacuum levels (-KPa)								Max. vacuum level -KPa	
			10	20	30	40	50	60	70	80		85
AVG 18	6.0	6.4	22	44	75	115	185	258	430	798	1107	85
AVG 25	6.0	9.6	15	30	52	80	128	178	297	538	764	85

ACCESSORIES AND SPARE PARTS UPON REQUEST

Art.	AVG 18	AVG 25
Sealing kit	art.	00 KIT AVG 18
Cables with solenoid valve connectors provided with built-in electronic device in the male M2 connector	art.	00 KIT AVG 25
Exhaust silencer	art.	00 15 309
Rear aluminium shockproof protection plate	art.	SSX 3/4 R
Front aluminium shockproof protection plate	art.	00 15 271
Digital micro vacuum switch	art.	00 15 272
Bistable supply solenoid valve	art.	12 05 11
Blowing solenoid valve NC	art.	00 15 297
		00 15 175

SINGLE-STAGE AND MULTI-FUNCTION VACUUM GENERATORS AVG 18 P and AVG 25 P

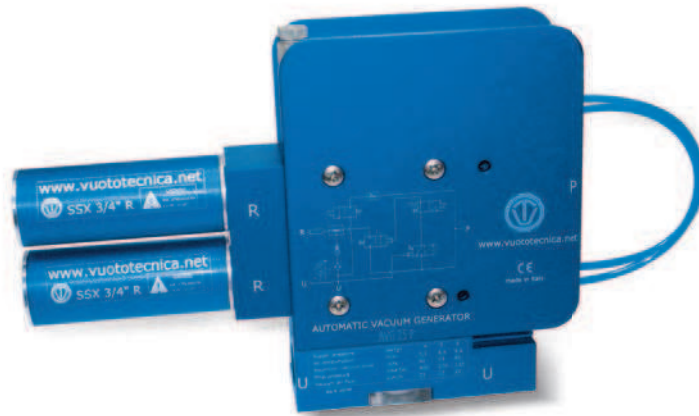

Protection devices

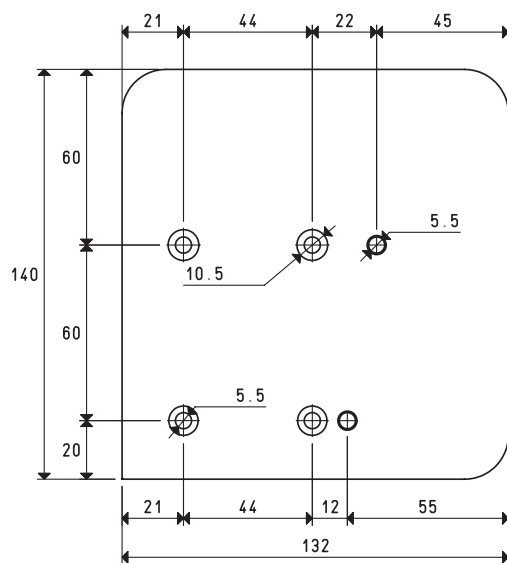
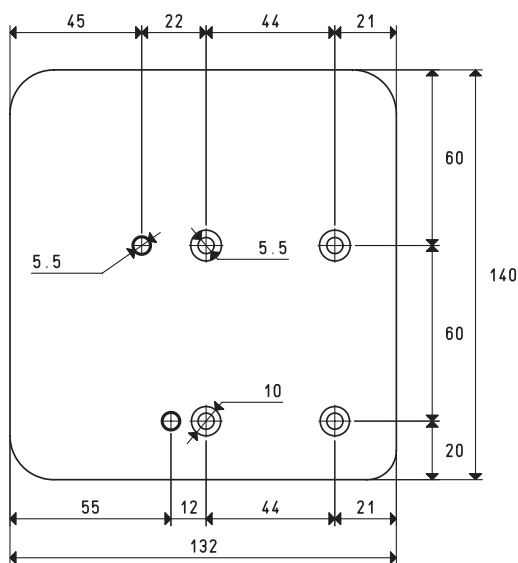

Art.	Description
00 15 271	Rear shockproof protection

Art.	Description
00 15 272	Front shockproof protection

Note: To order the generator provided with digital vacuum switch, add the letter V to the code (e.g.: AVG 25 P V).

ACCESSORIES AND SPARE PARTS FOR SINGLE-STAGE AND MULTI-FUNCTION VACUUM GENERATORS SERIES AVG

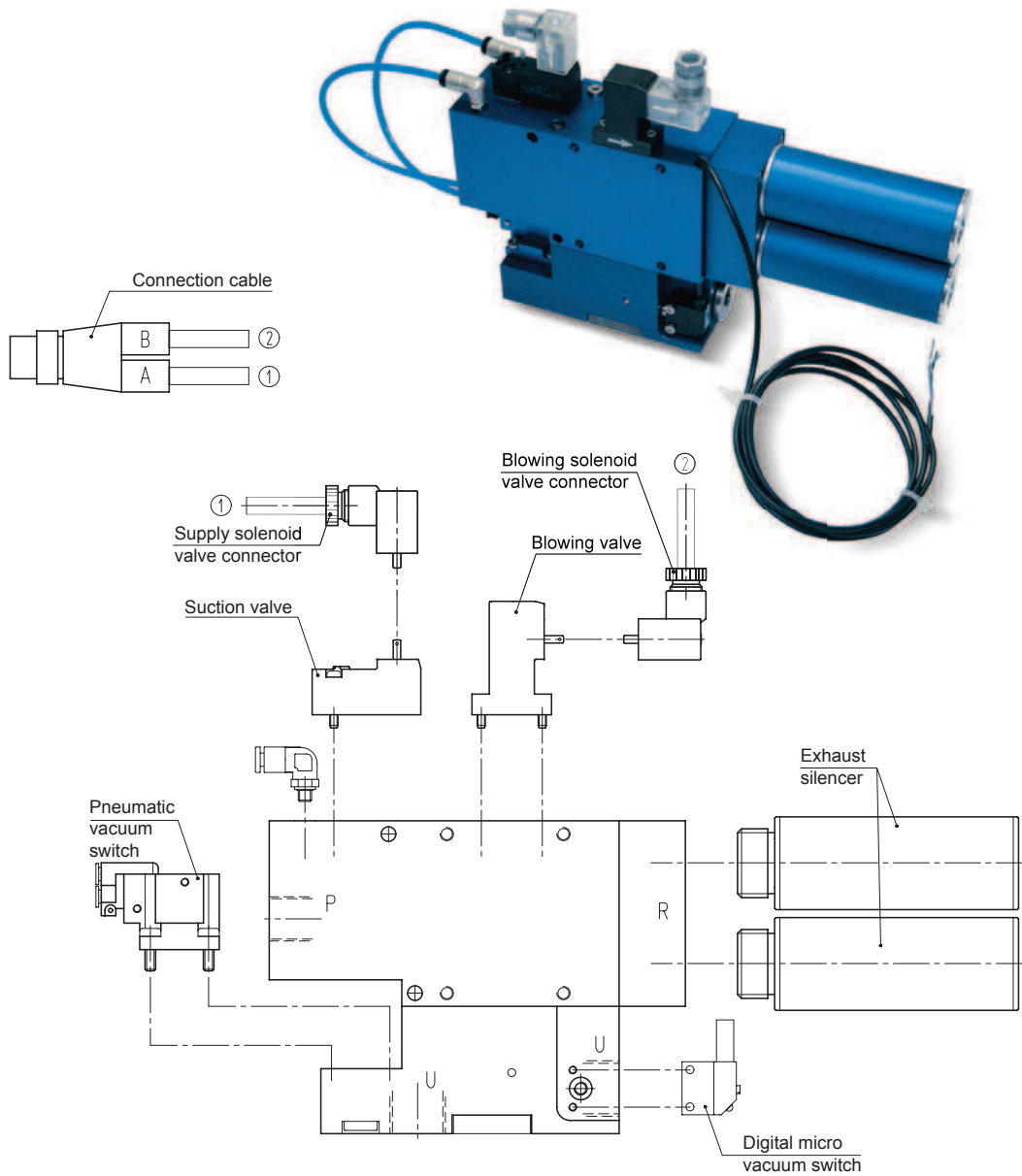

Cable with built-in electronic device

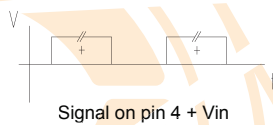
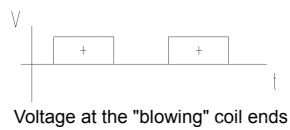
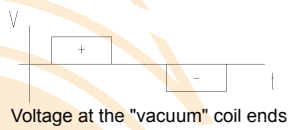
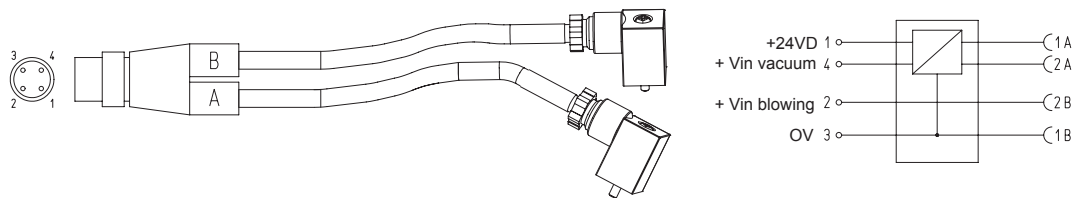

N°	Description
00 15 309	Cable with solenoid valve connectors with built-in electronic device in the male M12 connector.

ACCESSORIES AND SPARE PARTS FOR SINGLE-STAGE AND MULTI-FUNCTION VACUUM GENERATORS SERIES AVG

Digital micro vacuum switch



Art.	Description
12 05 11	Digital micro vacuum switch

Connector



Art.	Description
00 15 157	Connector with solenoid valve LED

Bistable micro solenoid valve



Art.	Description
00 15 297	Bistable supply solenoid valve

Micro solenoid valve NC

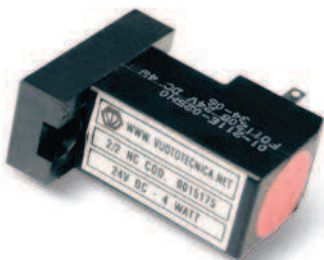

Art.	Description
00 15 175	Blowing solenoid valve NC

Silencer



Art.	Description
SSX 3/4" R	Exhaust silencer